

VELUX®

**EFW/EFL/EFS
+EBY W10 ■**

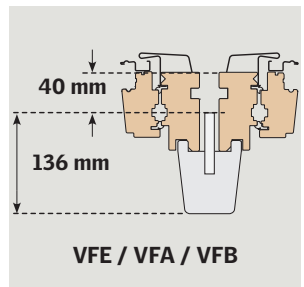

VAS 453327-2022-06

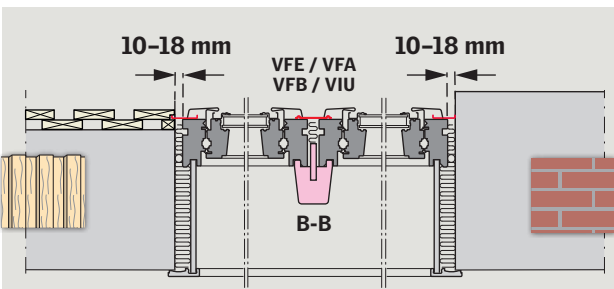
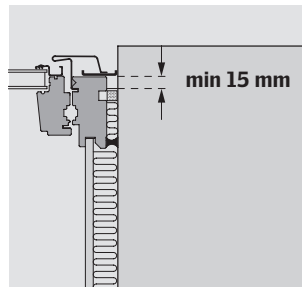
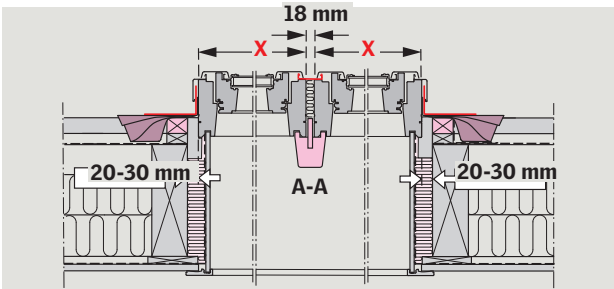
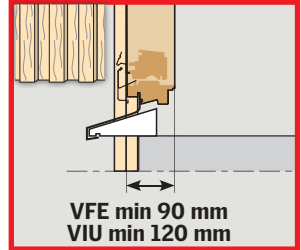
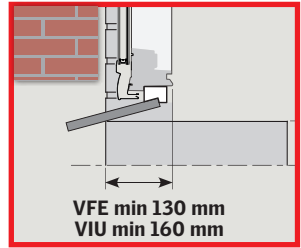
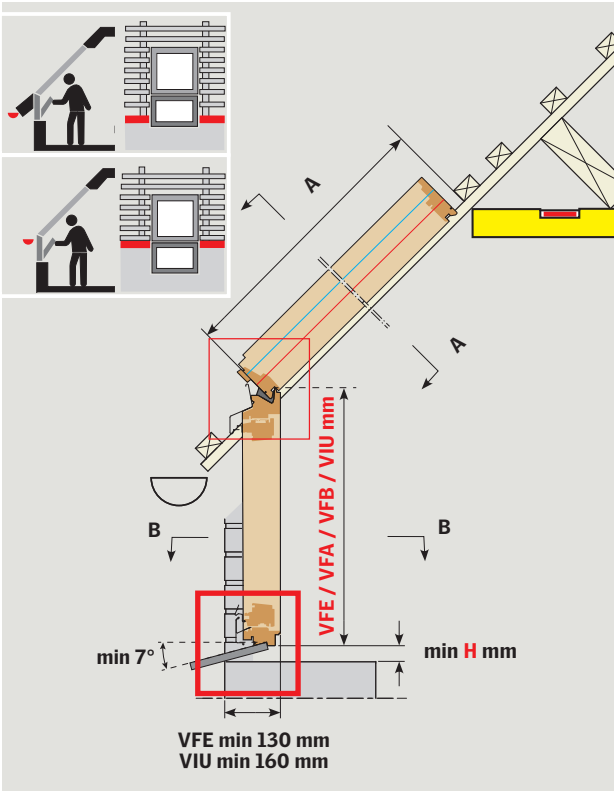

VIU

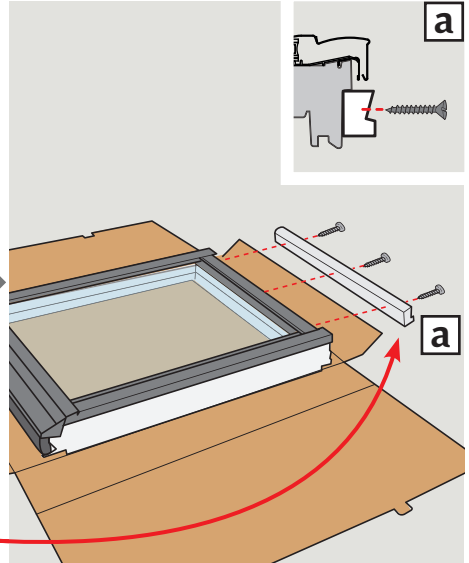
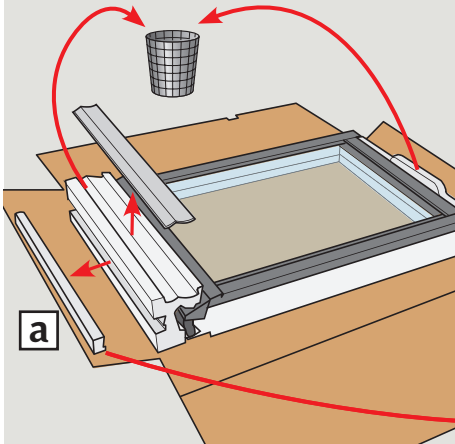

VFE/VFA/VFB

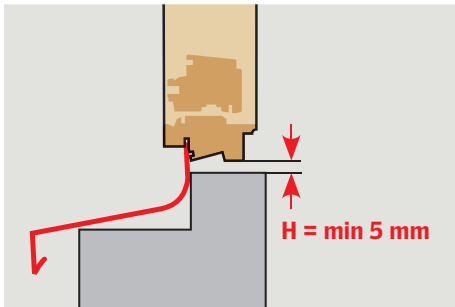
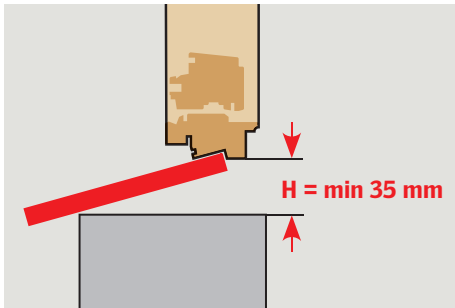

VIU

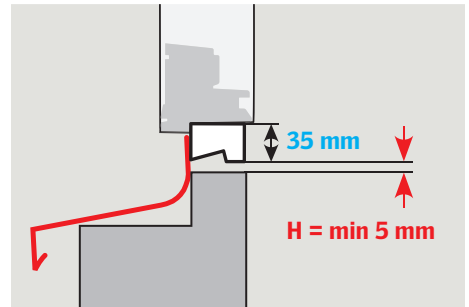
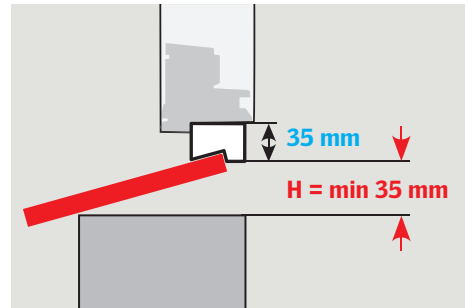

1

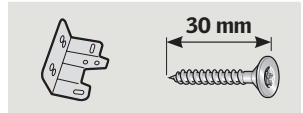
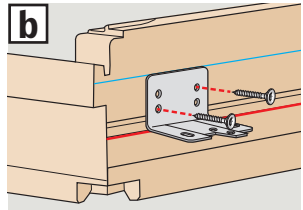
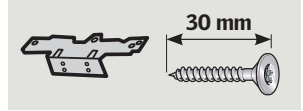
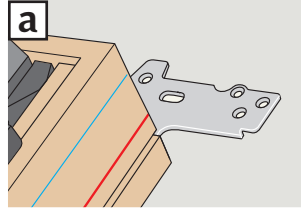
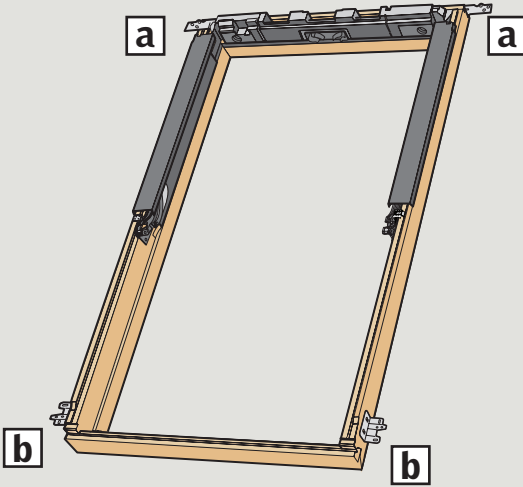

1a VFE/VFA/VFB

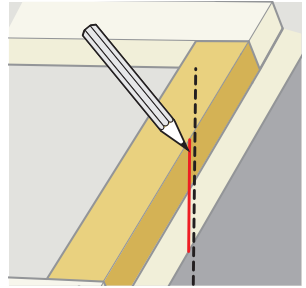
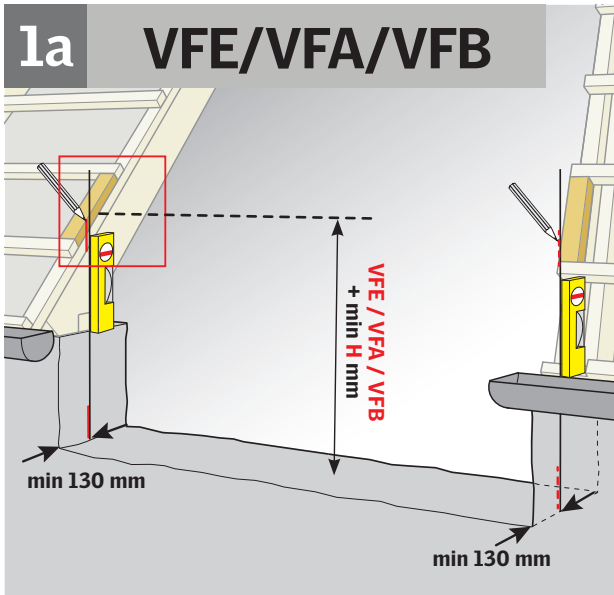

1b VIU

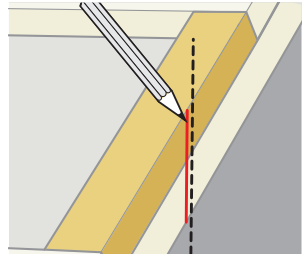
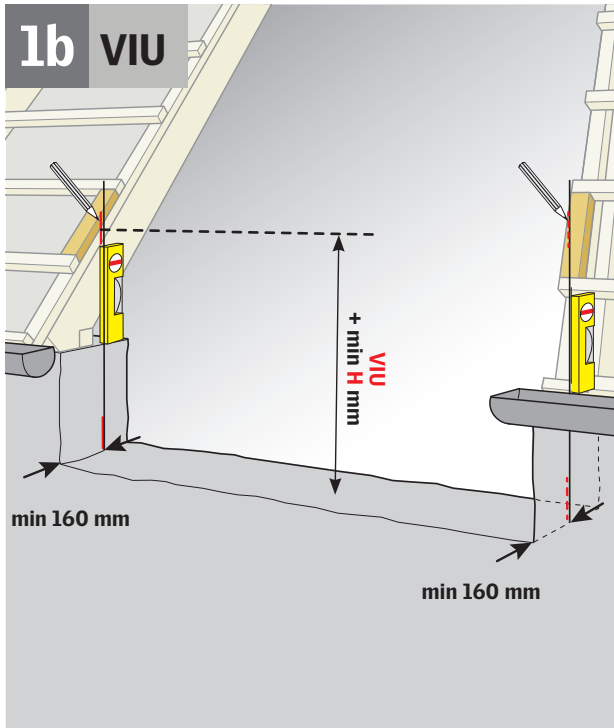

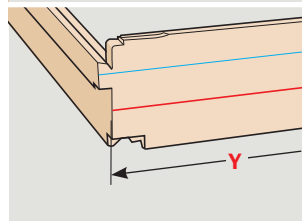
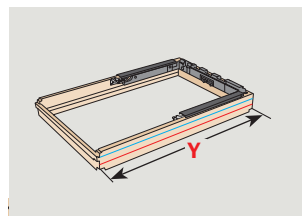
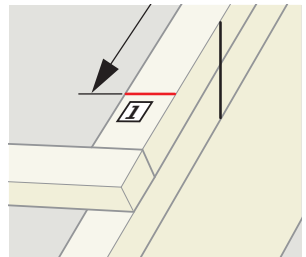
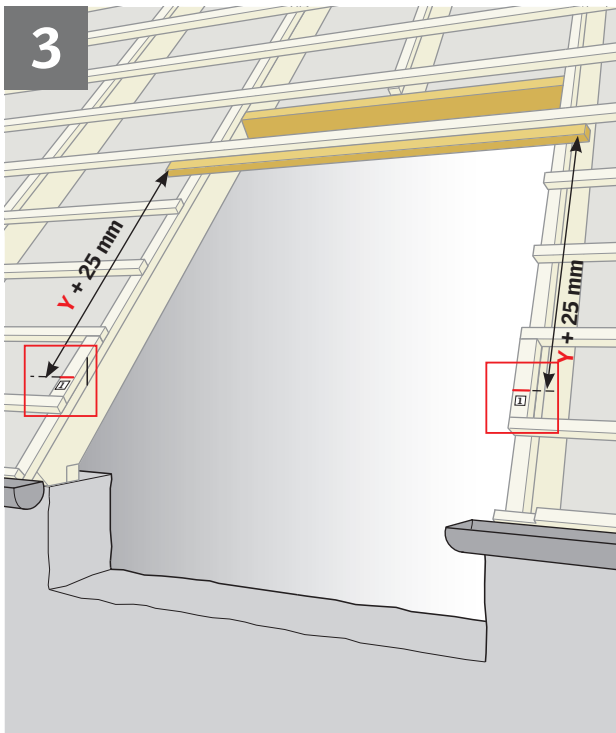
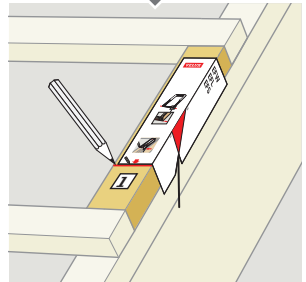
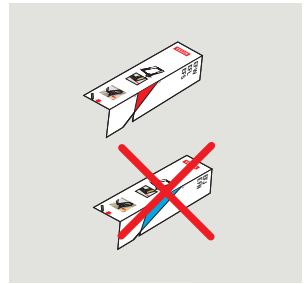
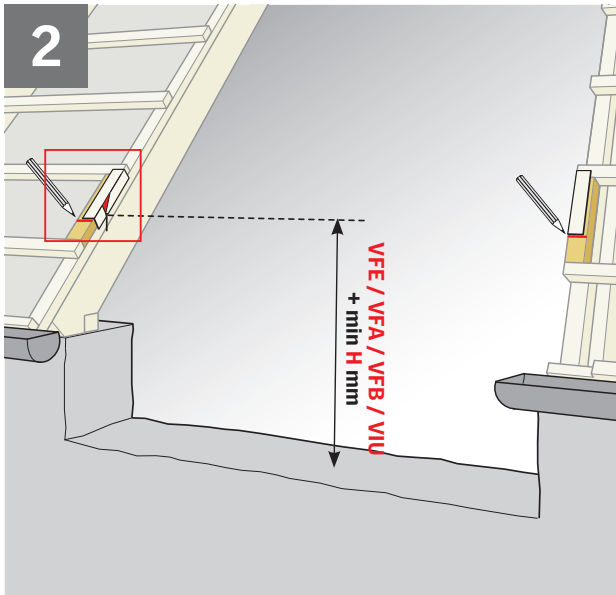

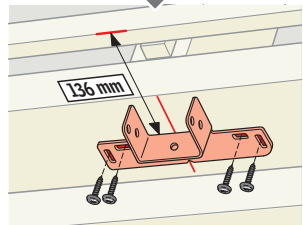
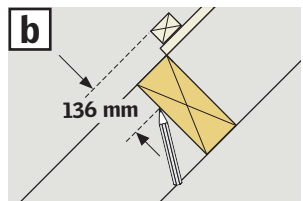
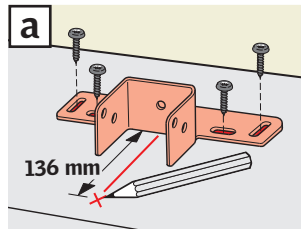
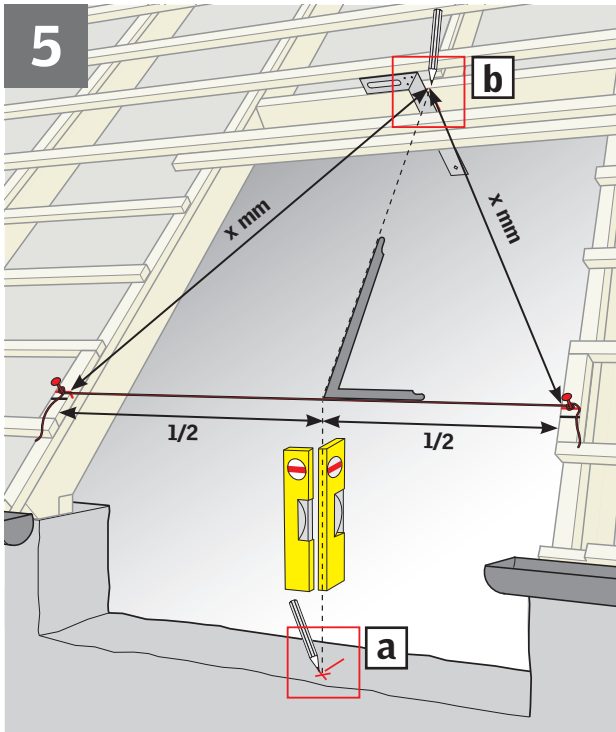
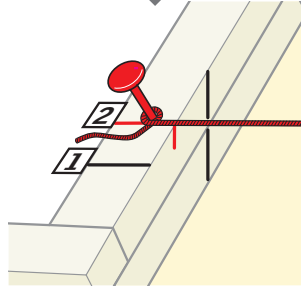
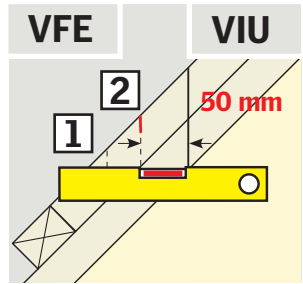
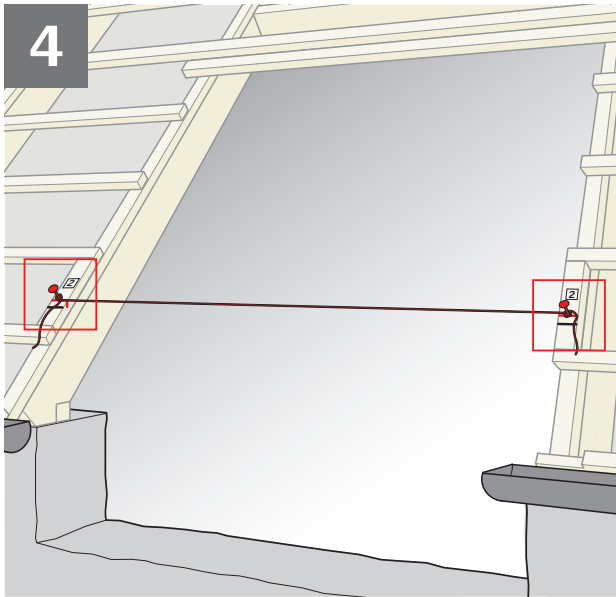

6

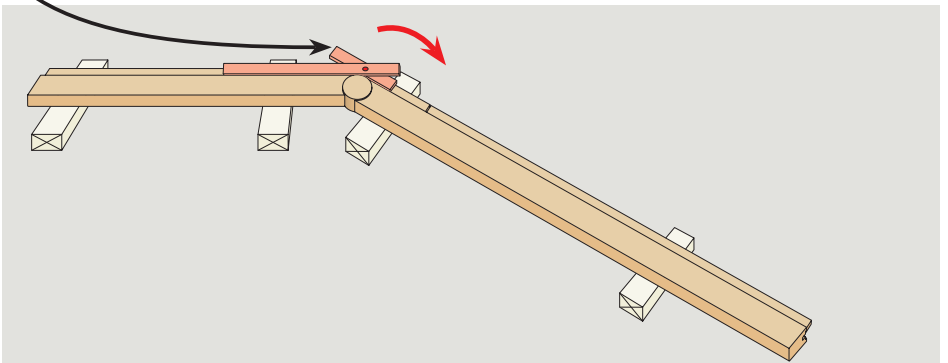
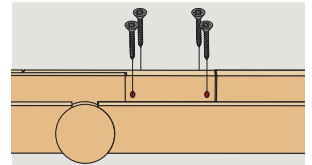
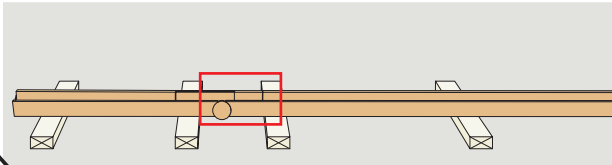
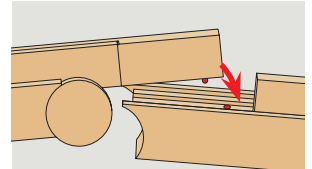
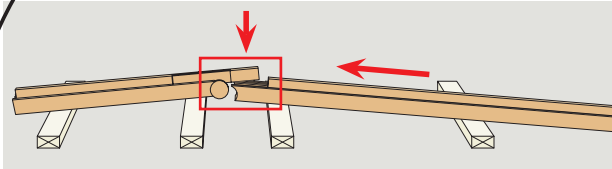
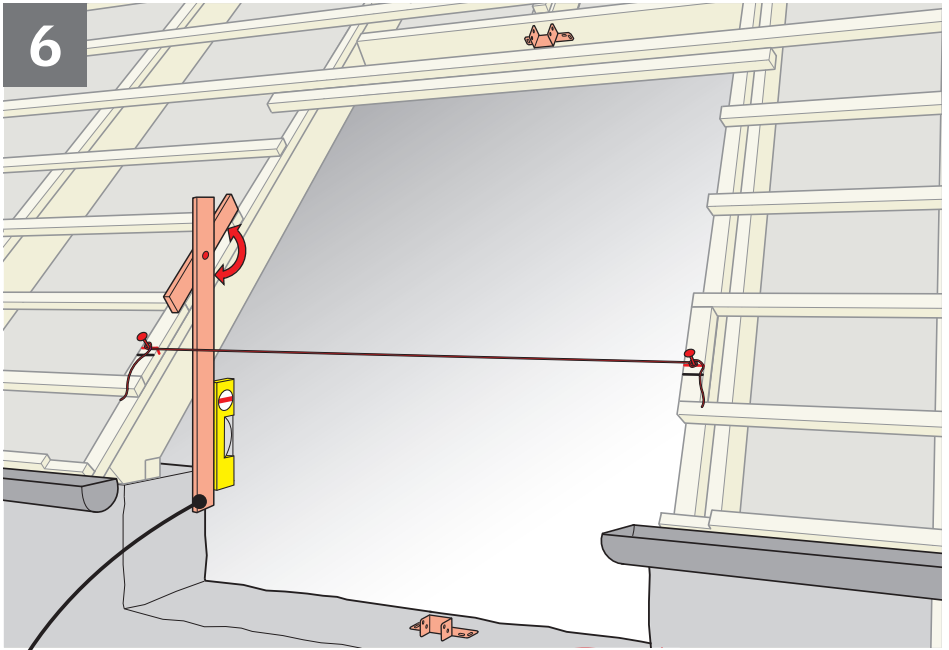

7

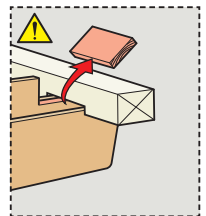
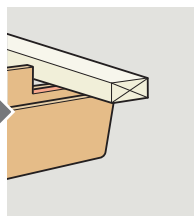
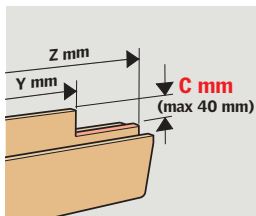
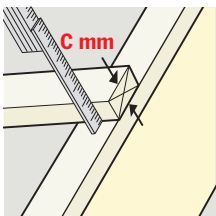
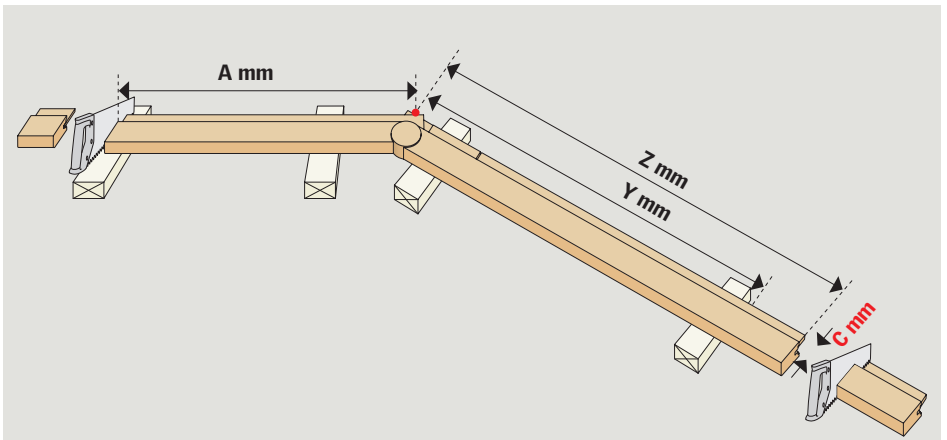
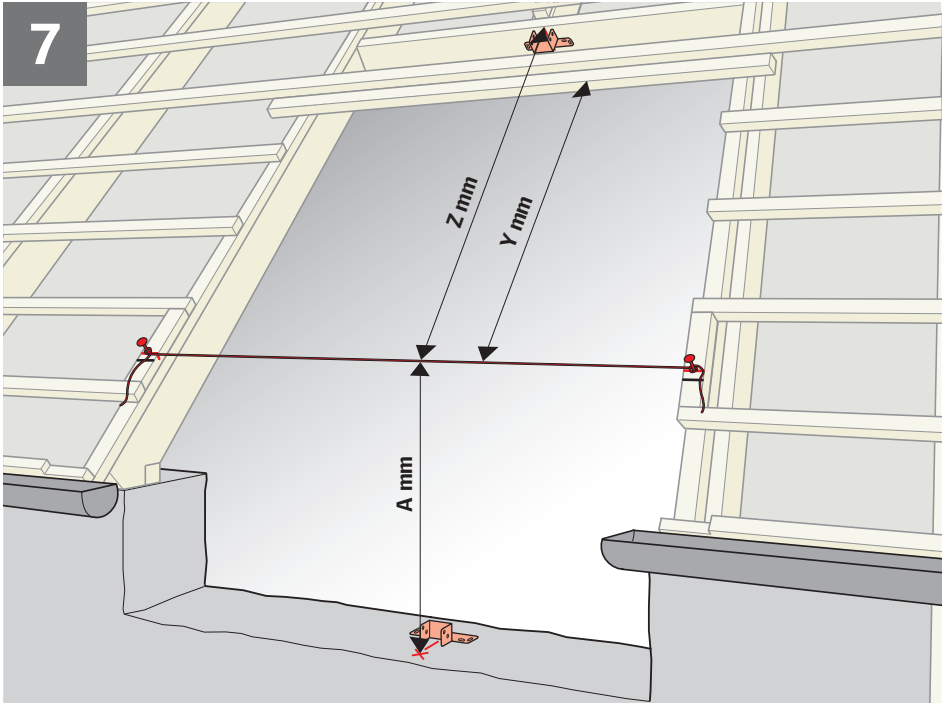

8

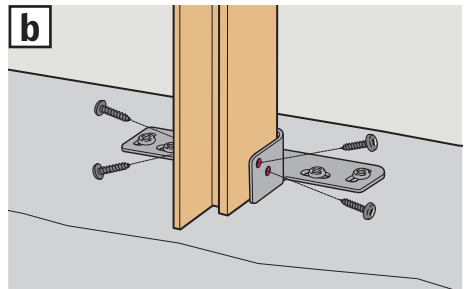
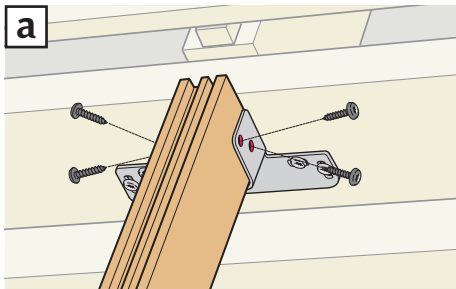
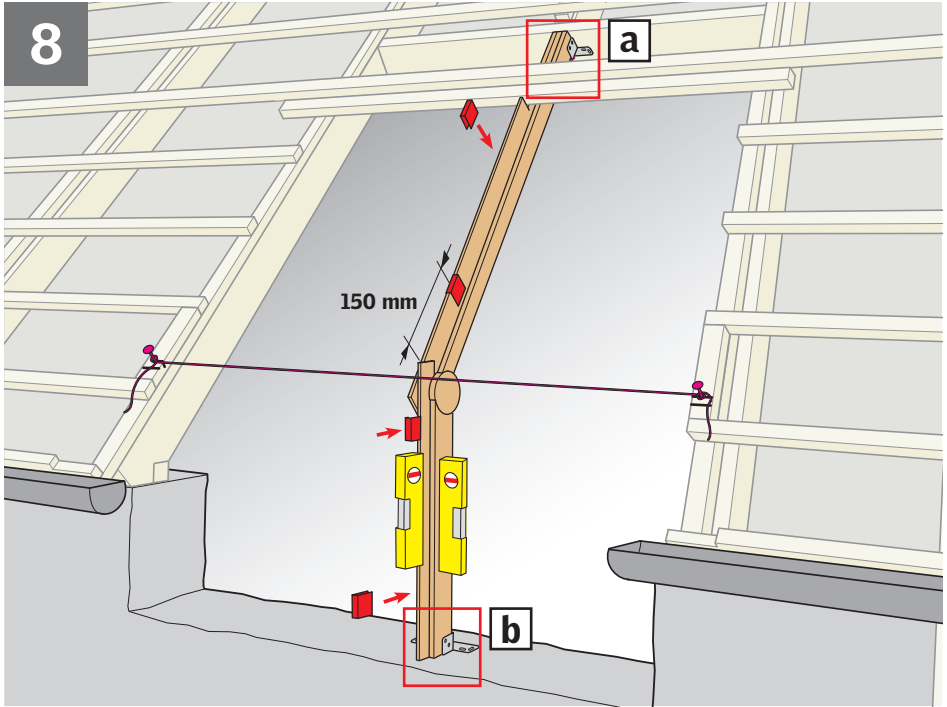

9

BDX

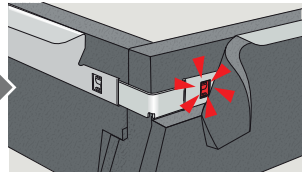
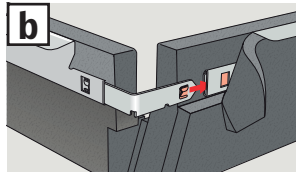
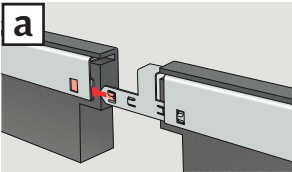
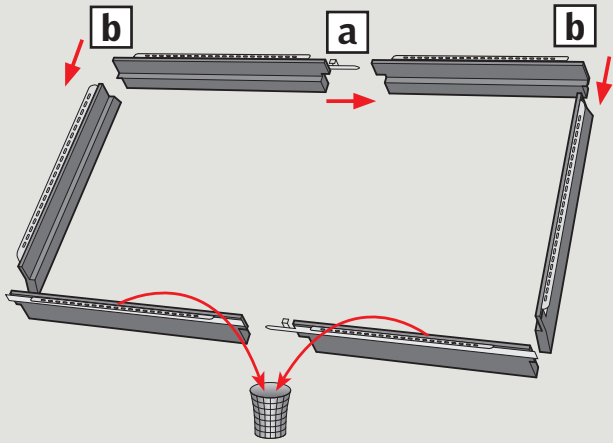

10

BDX

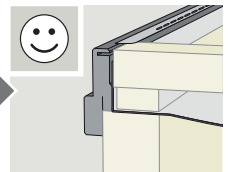
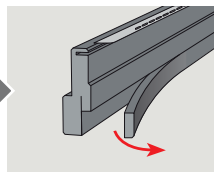
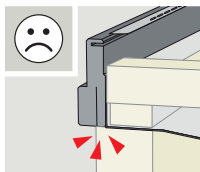
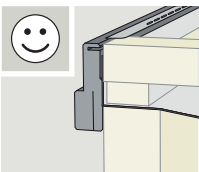
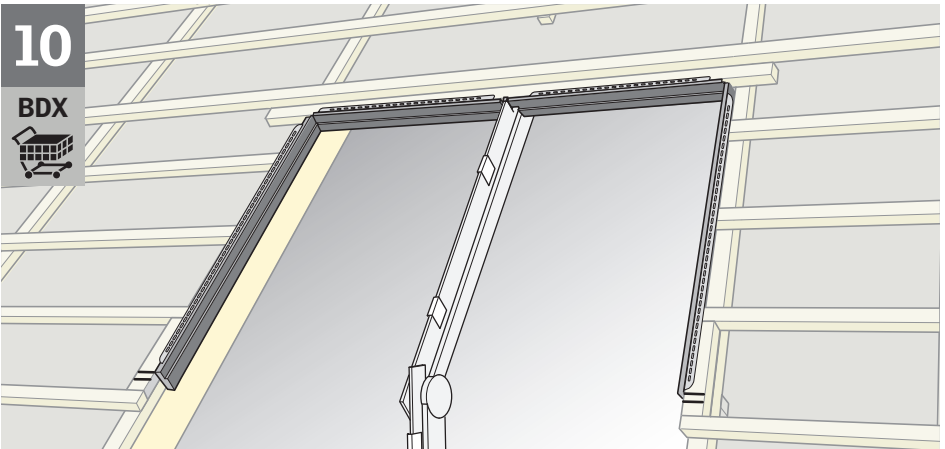

11

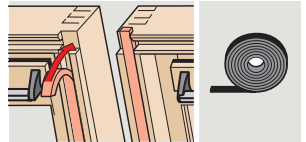
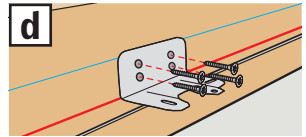
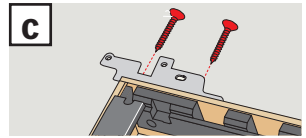
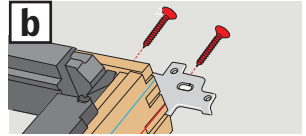
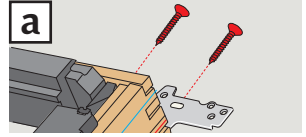
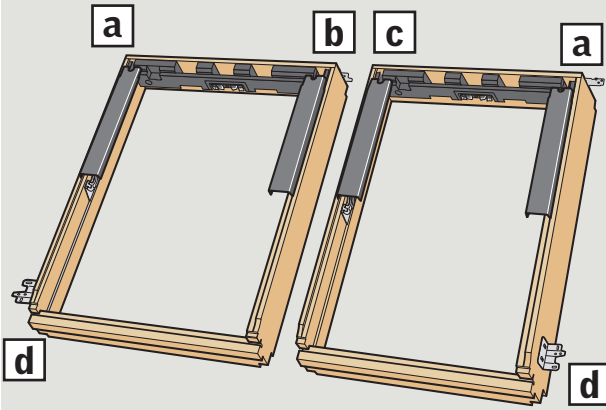

12

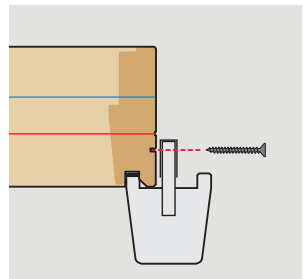
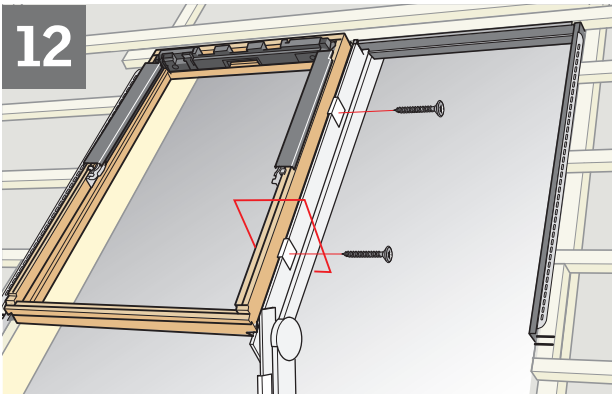

13

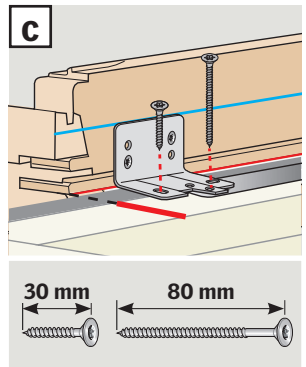
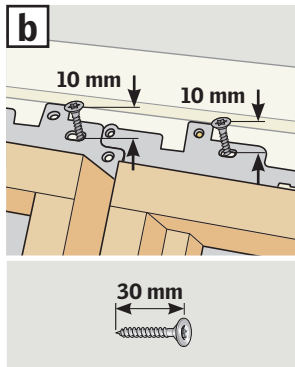
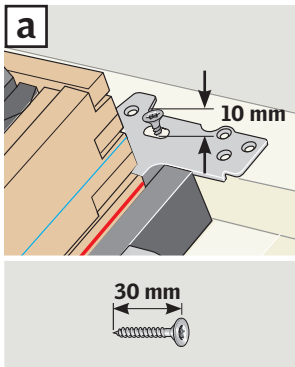
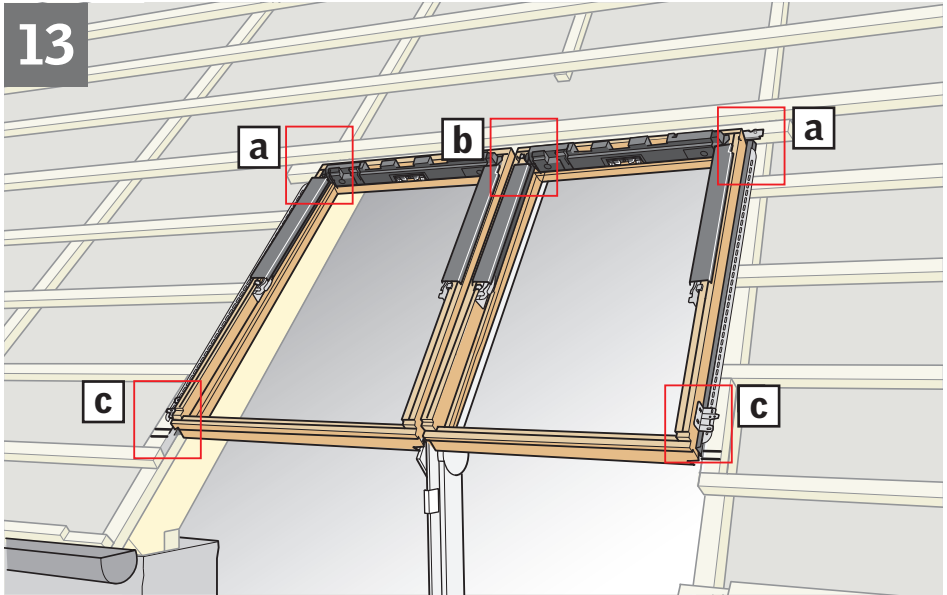

14

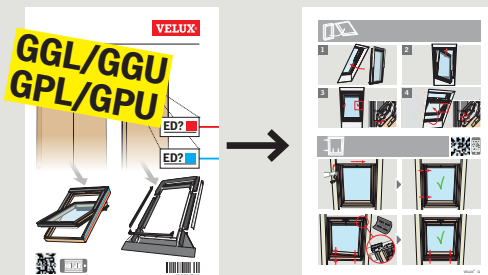

15

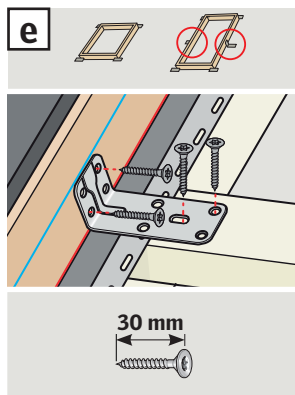
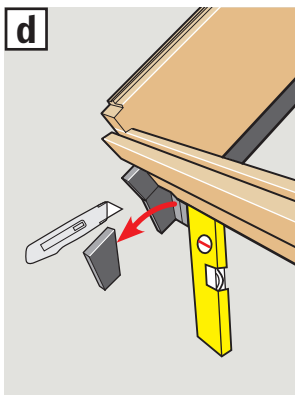
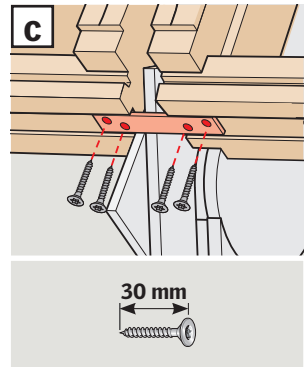
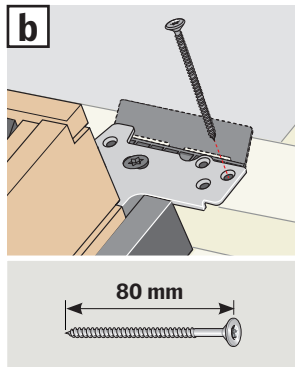
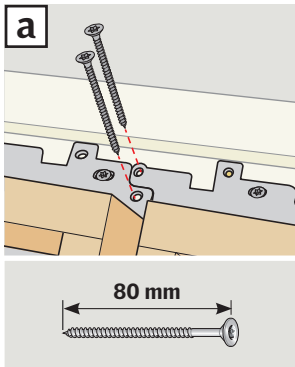
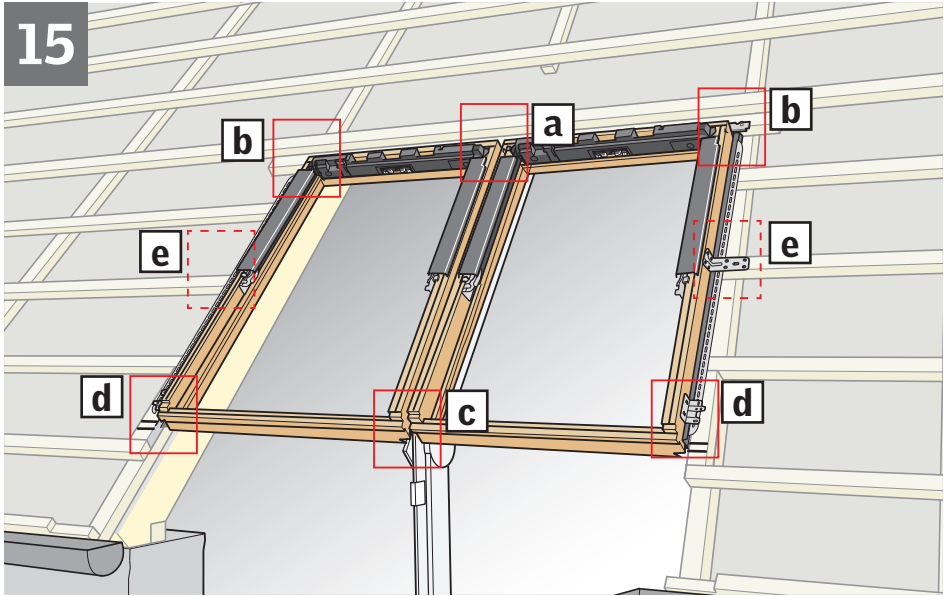

16

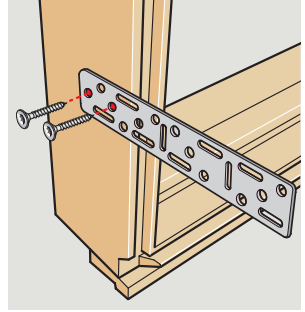
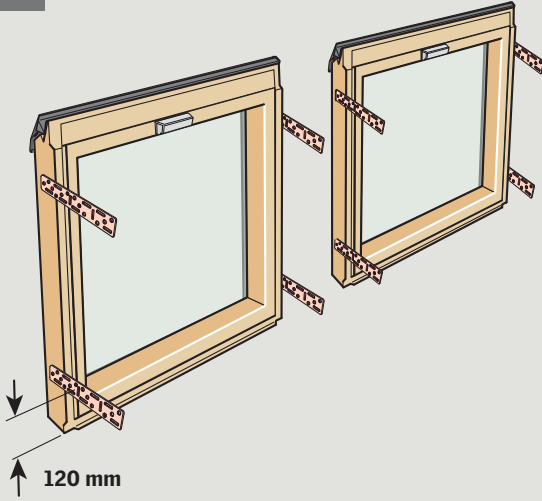

30 mm



17

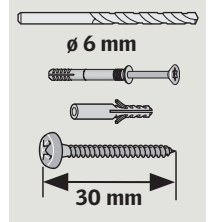
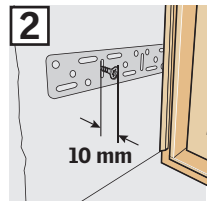
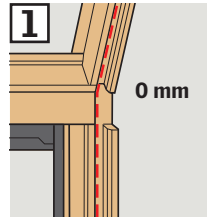
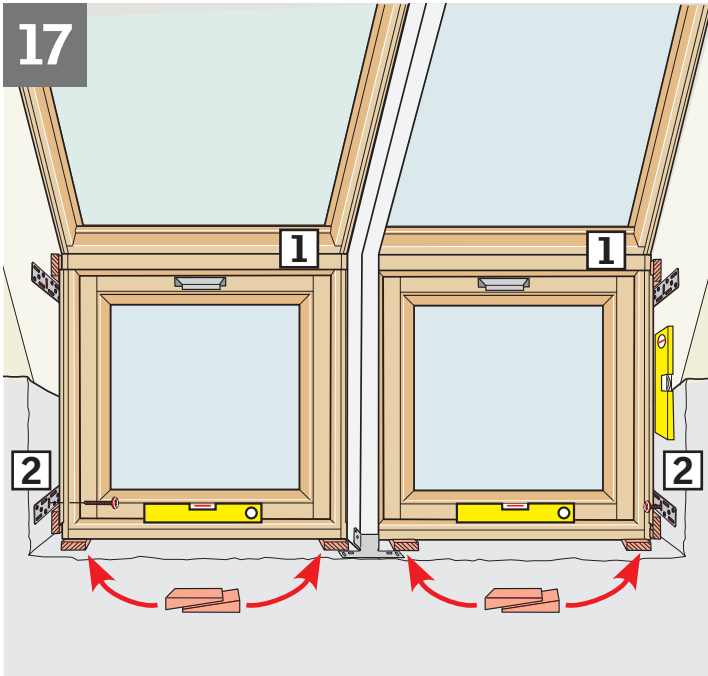

18a VFE

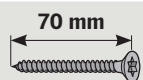
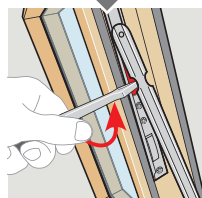
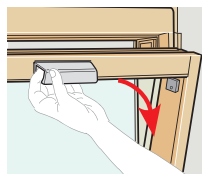
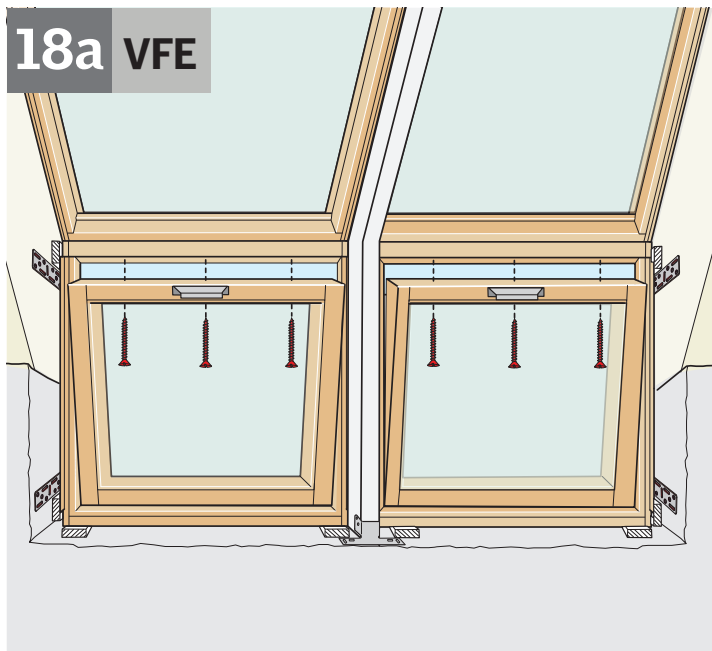

18b VIU

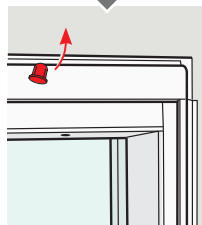
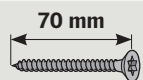
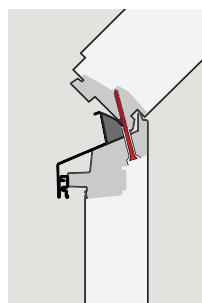
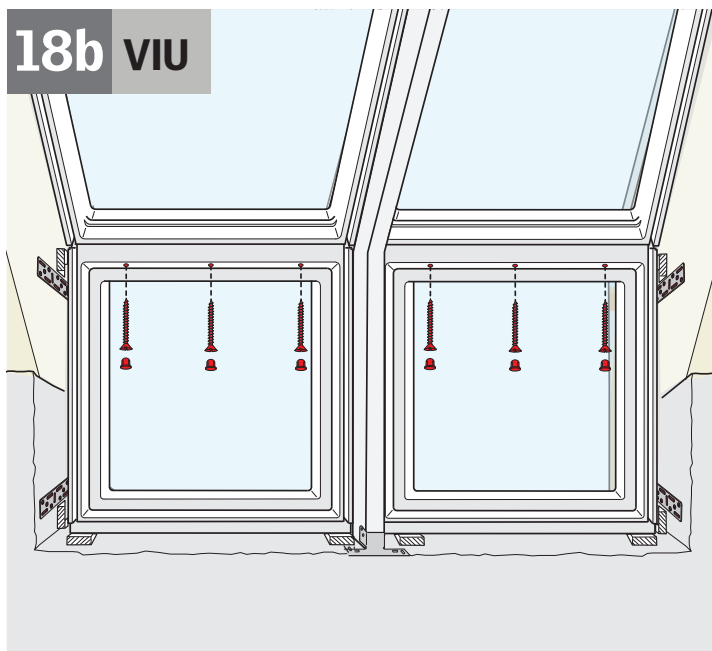

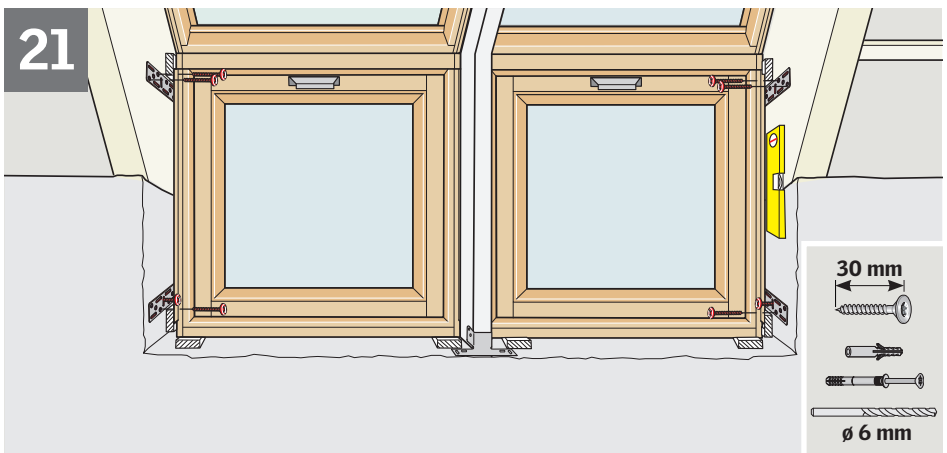
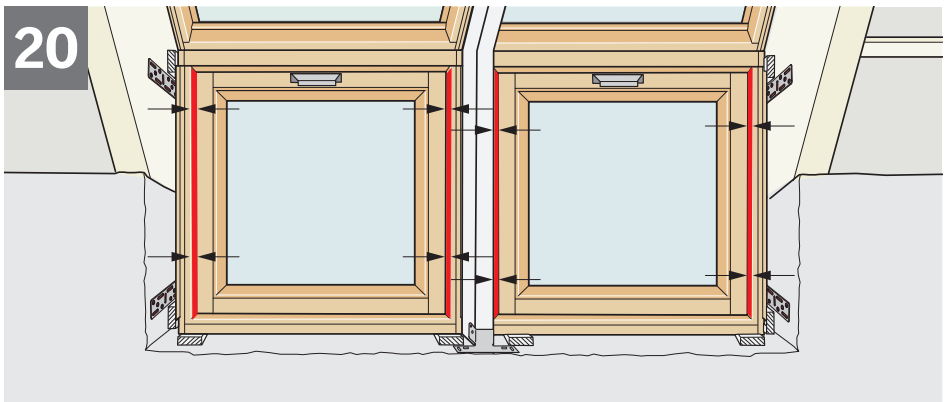
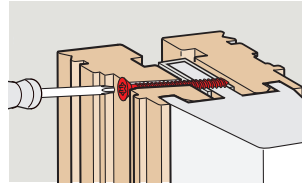
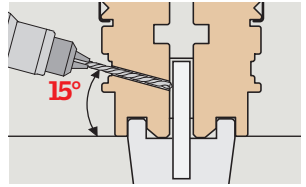
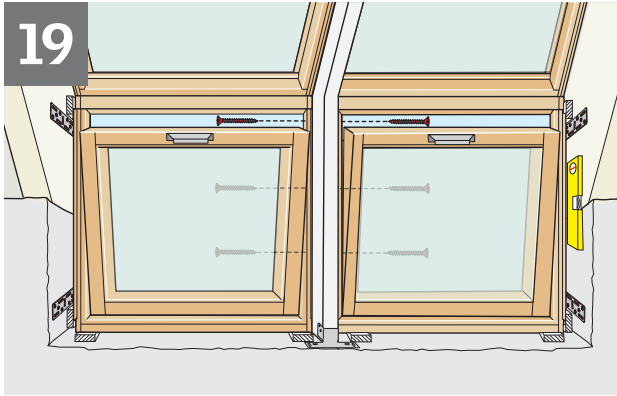

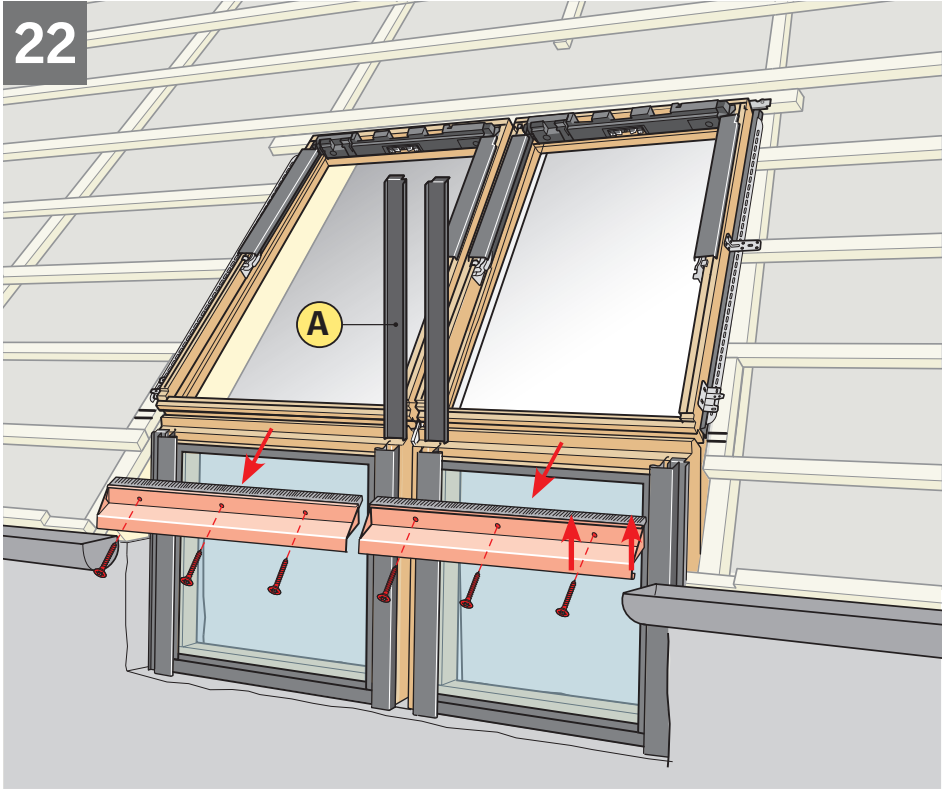

23a

VFE

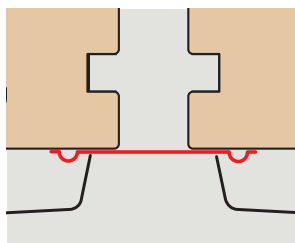
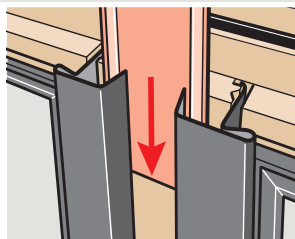
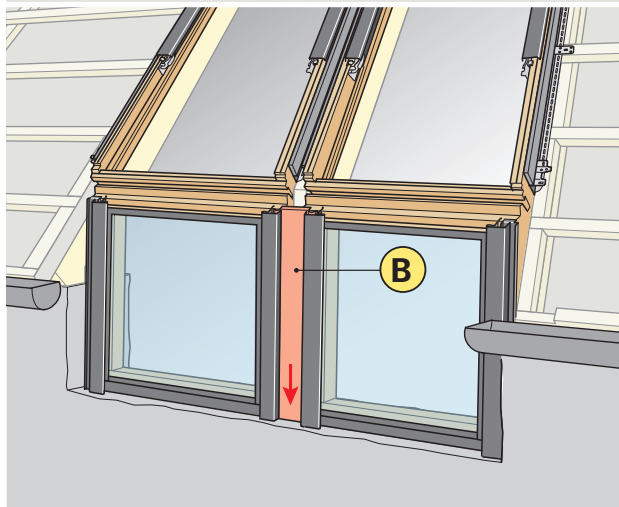
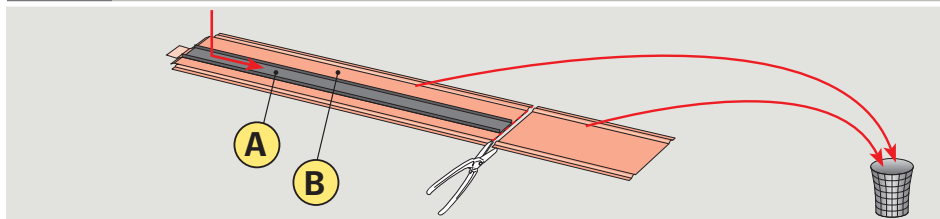

24a

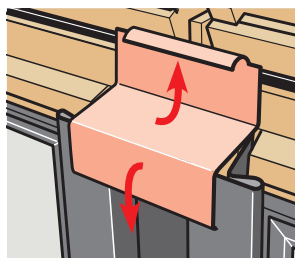
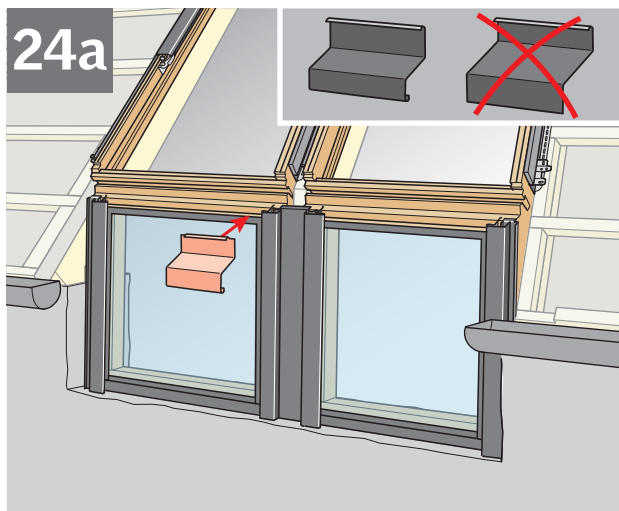

23b

VIU

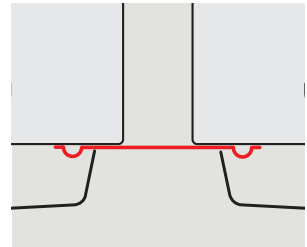
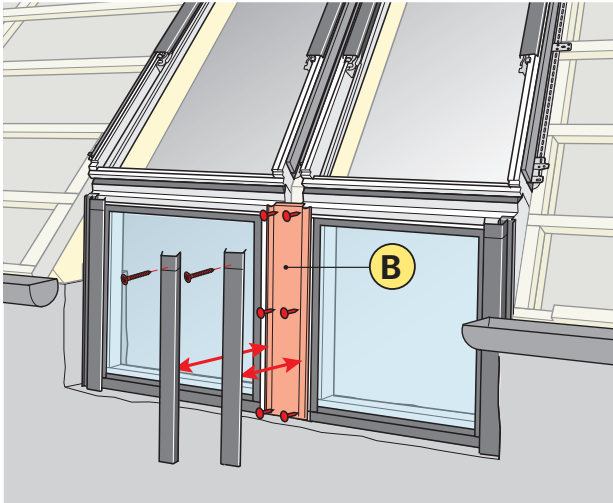
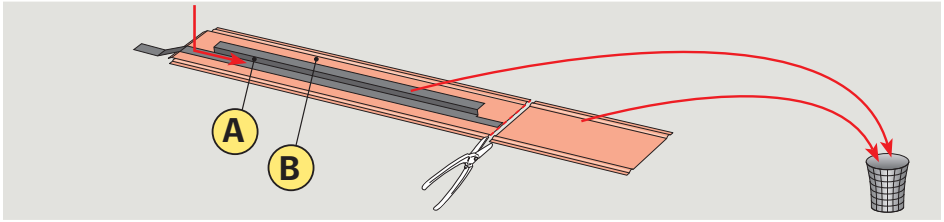

24b

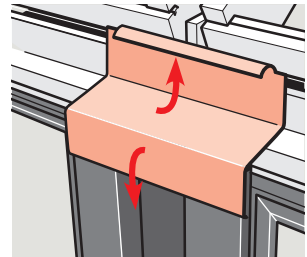
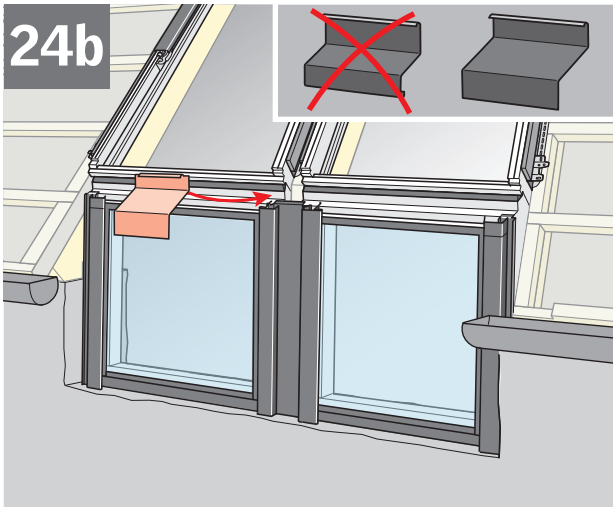

25

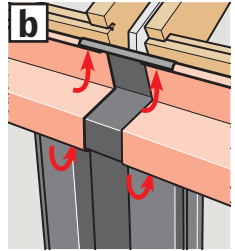
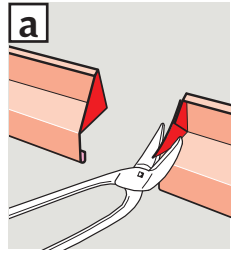
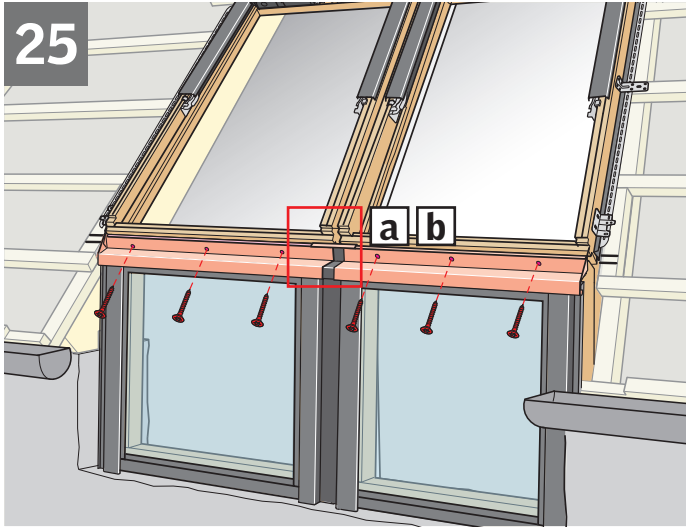

26

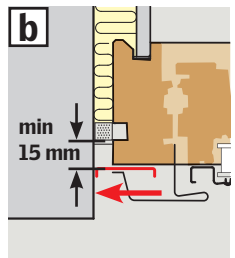
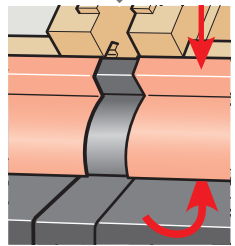
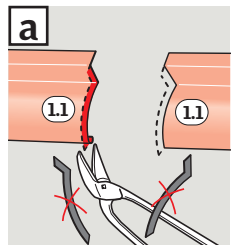
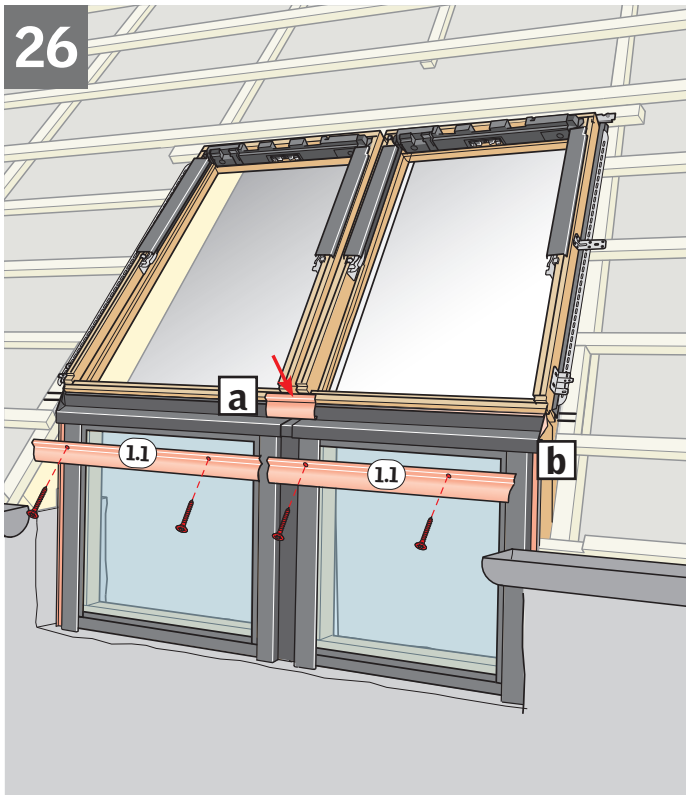

27

BDX

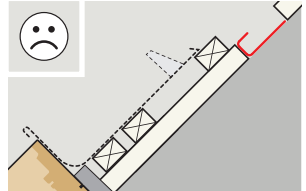
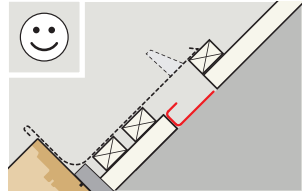
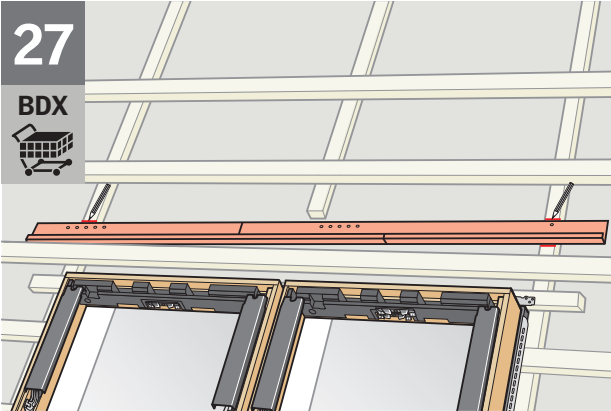

28

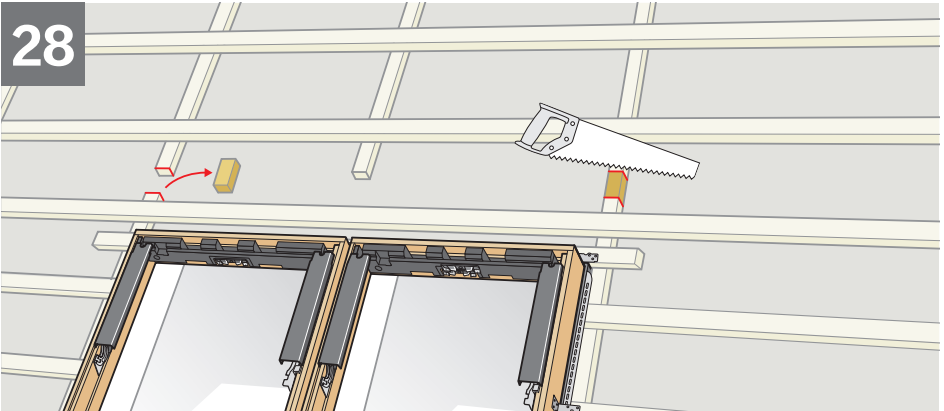

29

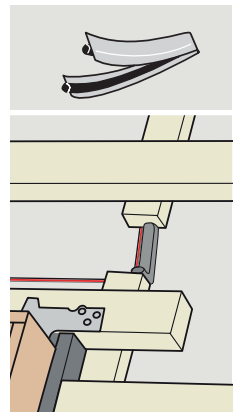
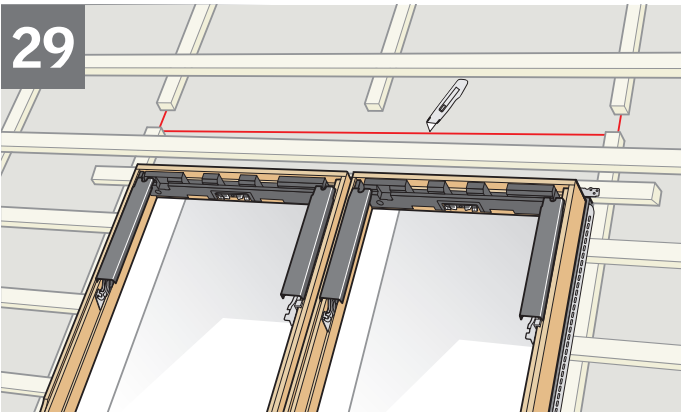

30

BFX

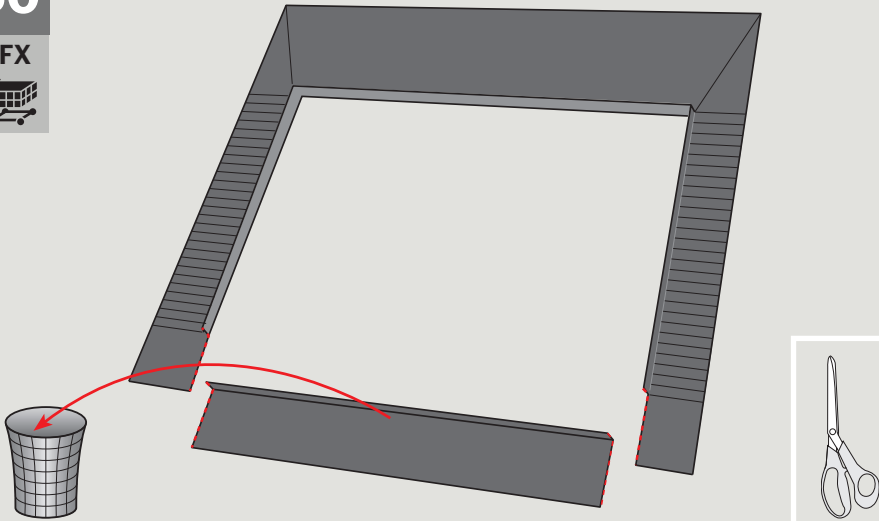

31

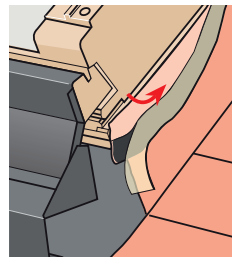
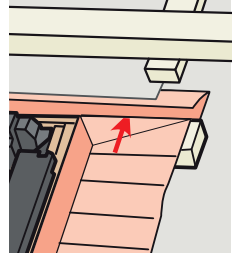

32

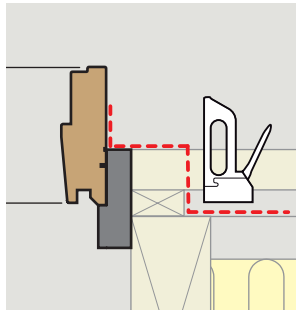
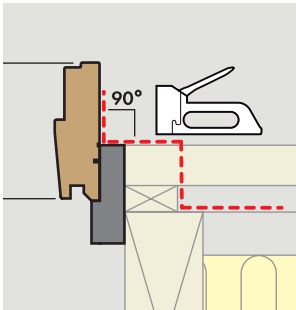
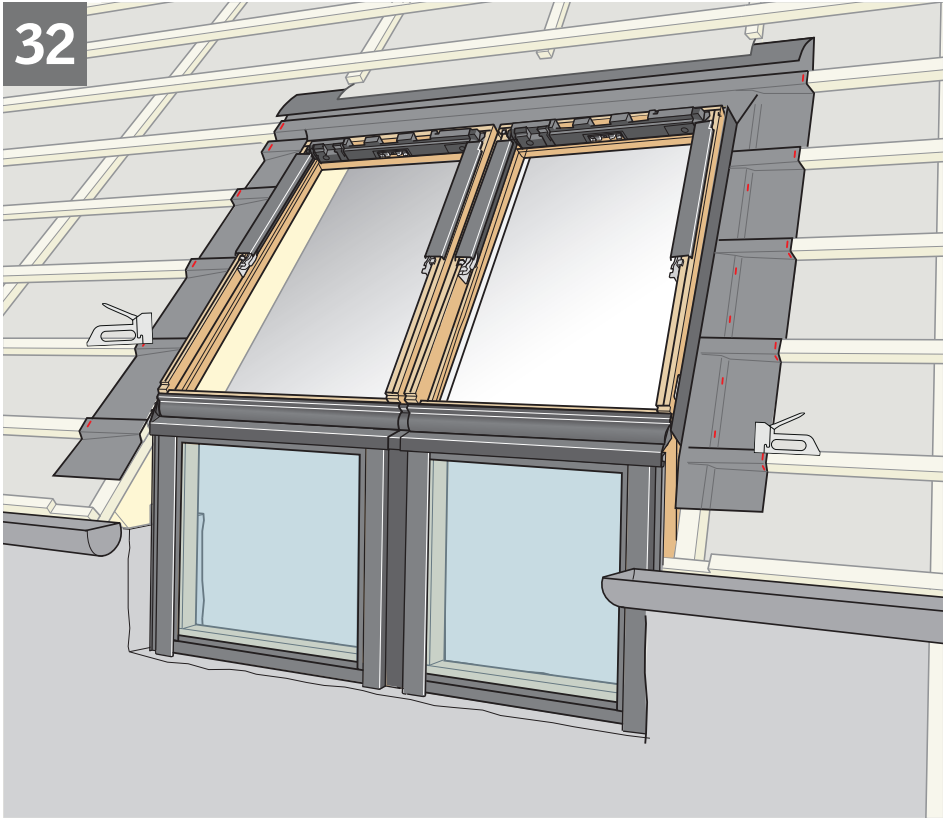

33

BDX

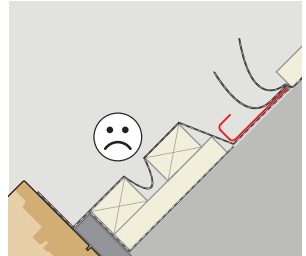
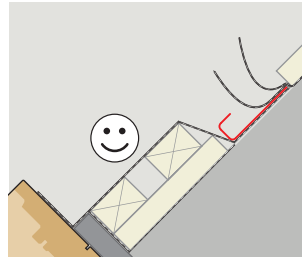
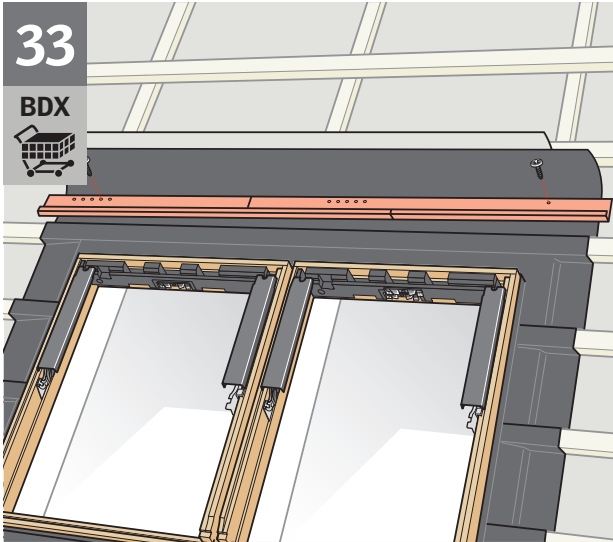

34

BDX

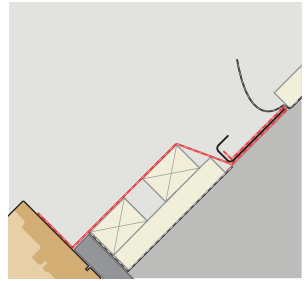
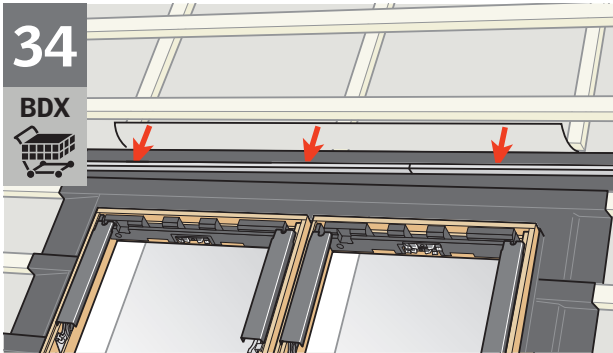

35

BDX

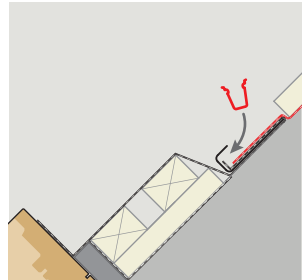
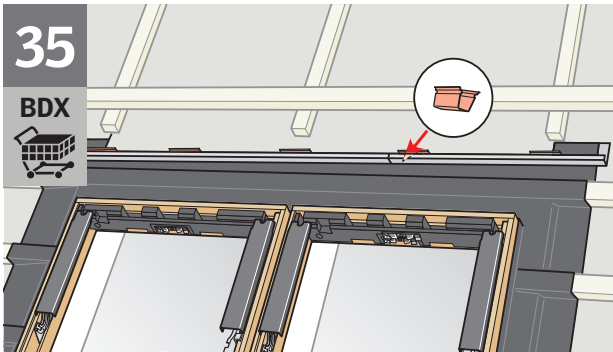

36

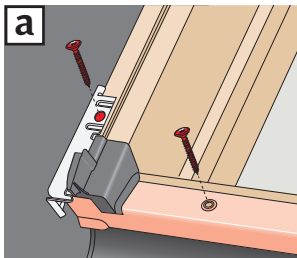
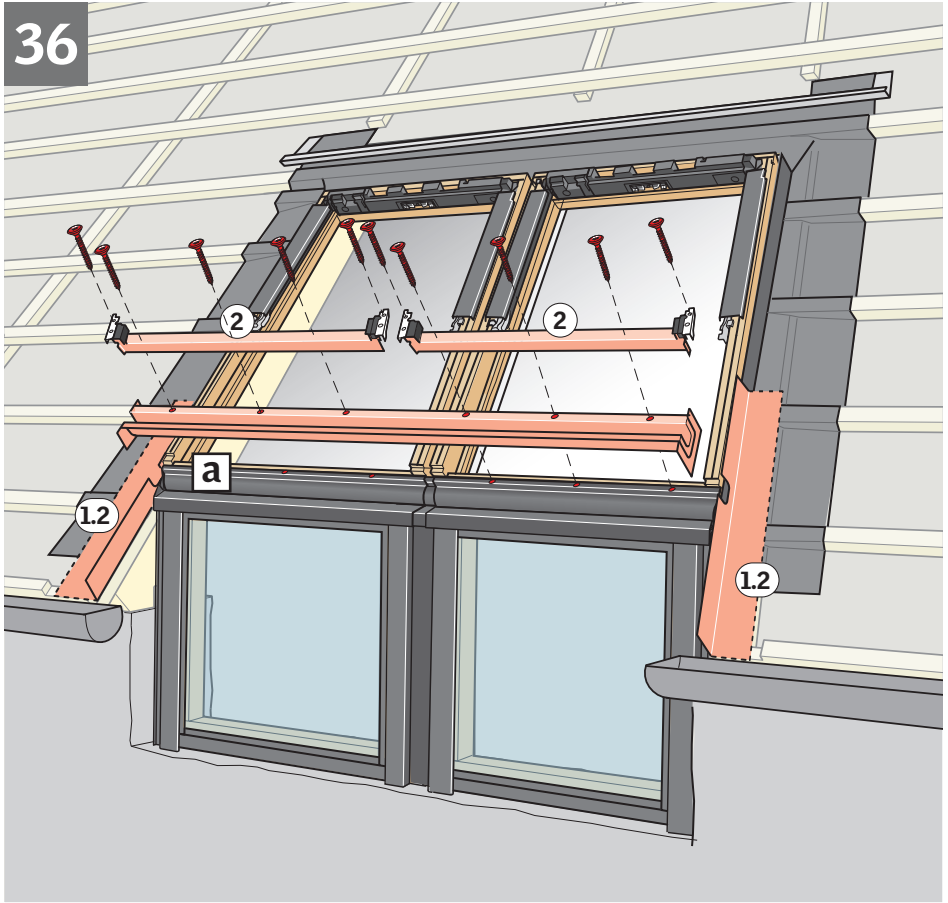

37a

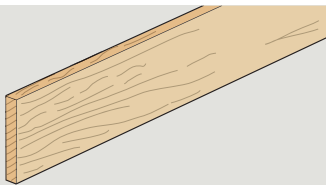
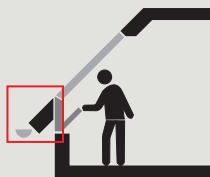

VFE

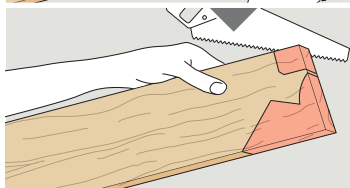
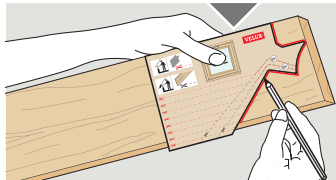
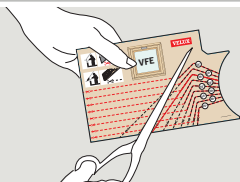

VIU

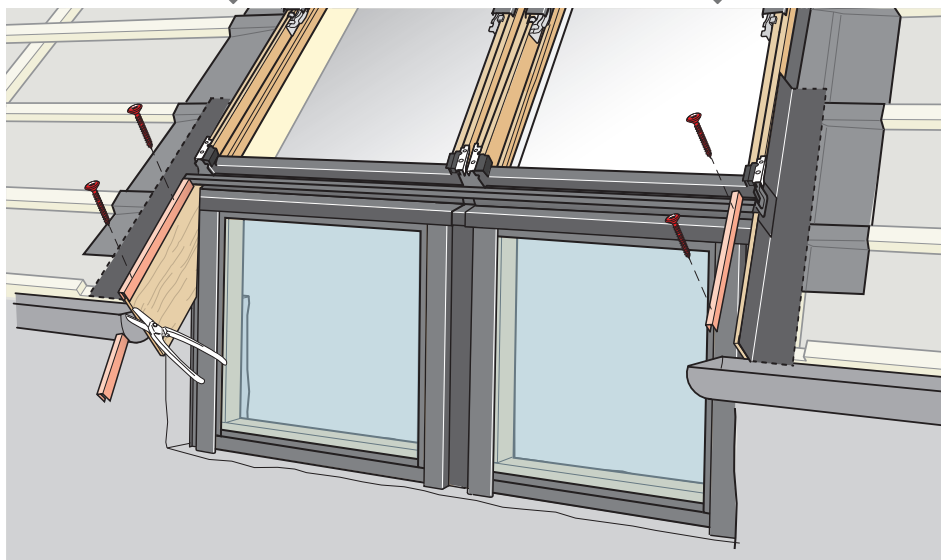
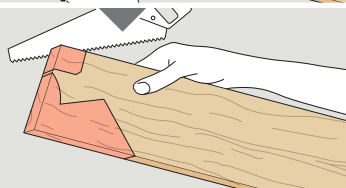
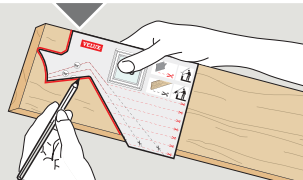
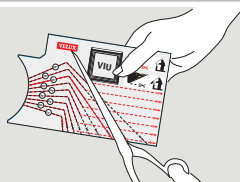

37b

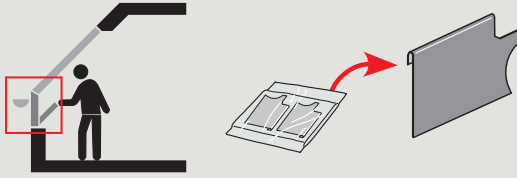

VFE

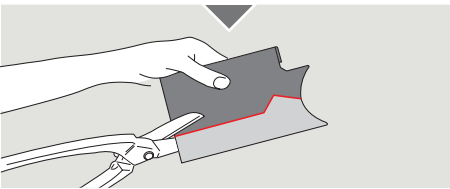
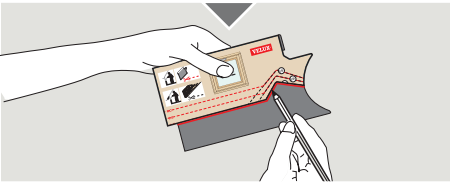
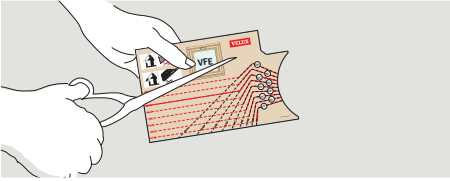

VIU

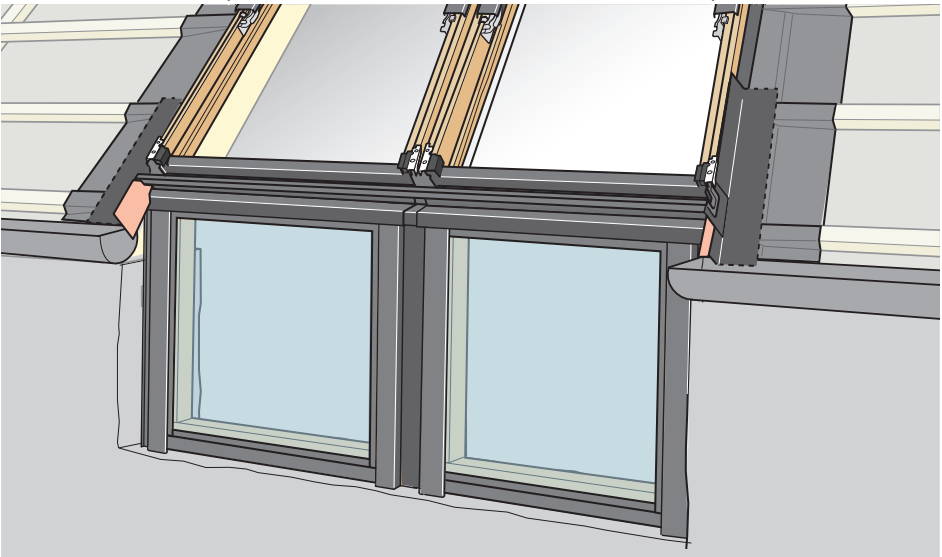
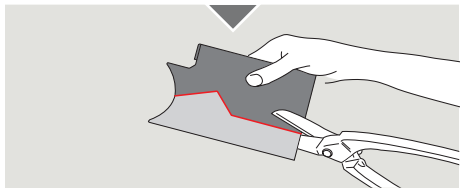
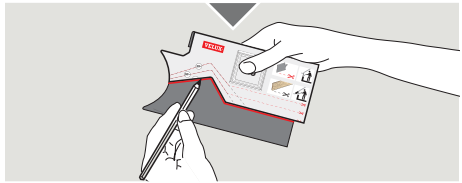
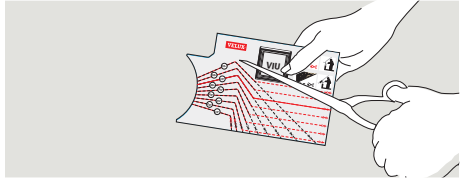

38

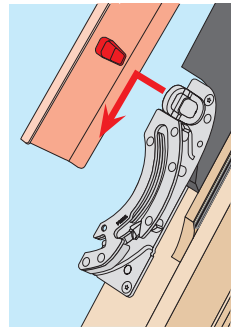
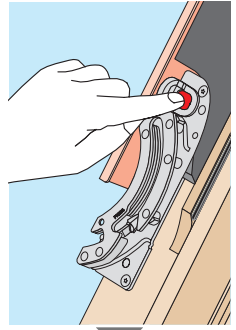
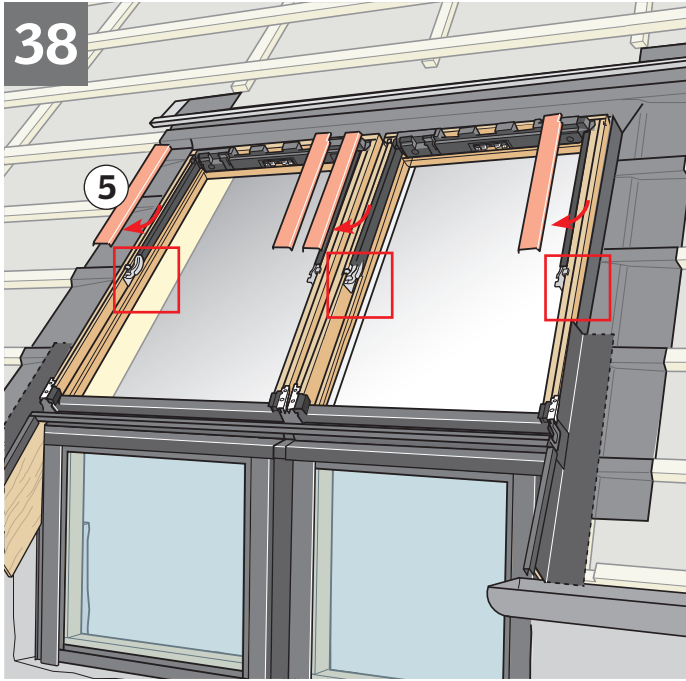

39

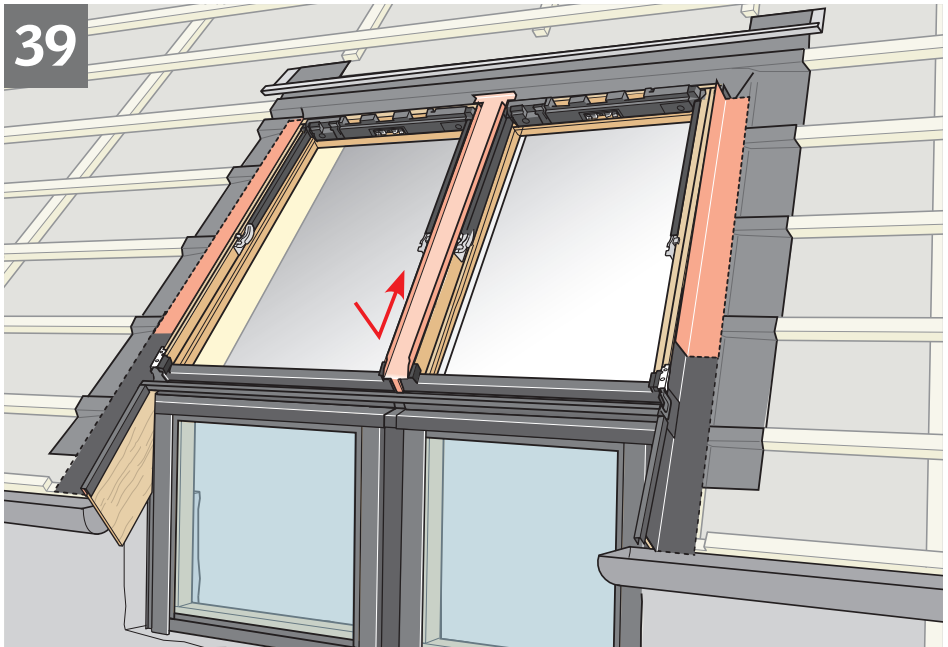

40

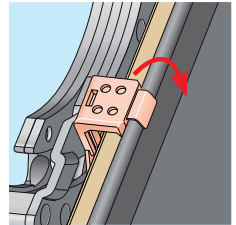
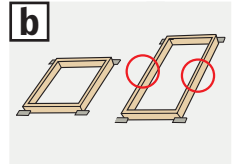
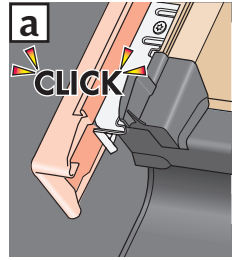
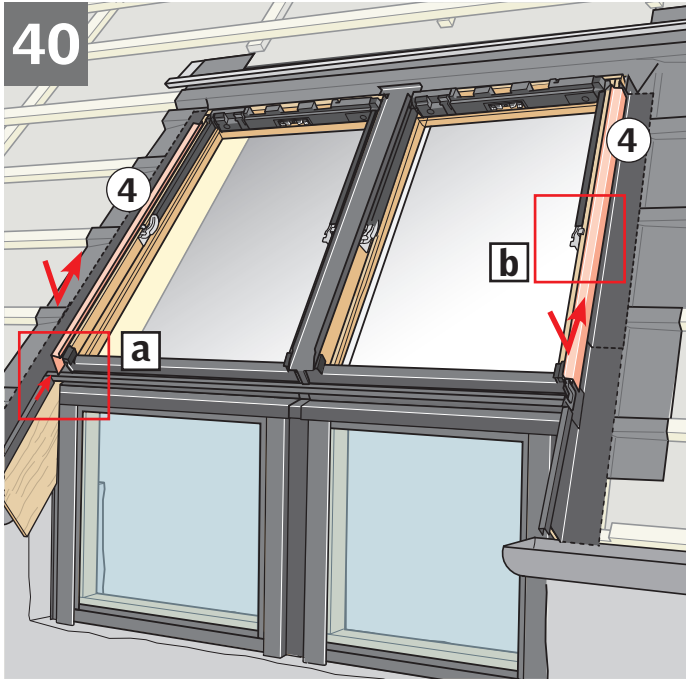

41

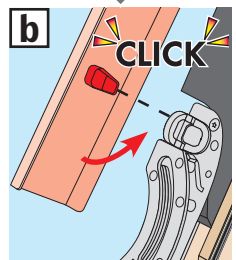
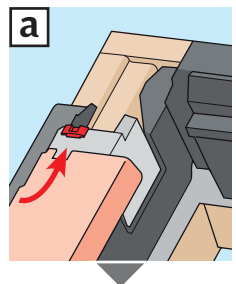
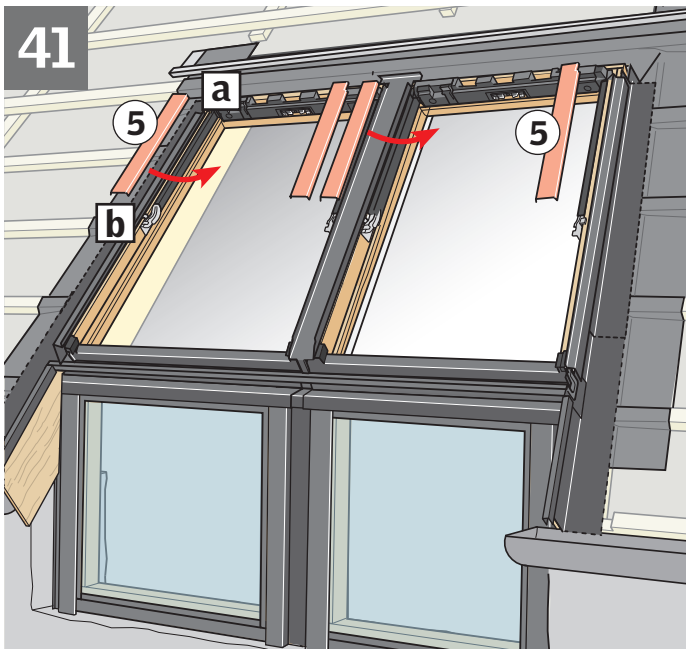

42

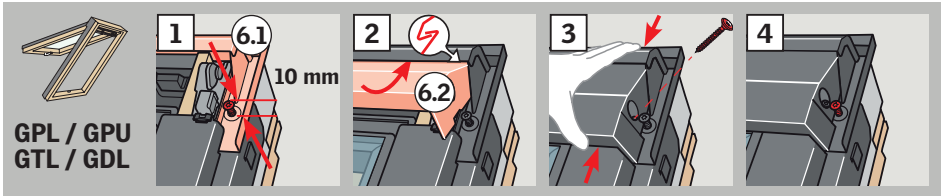
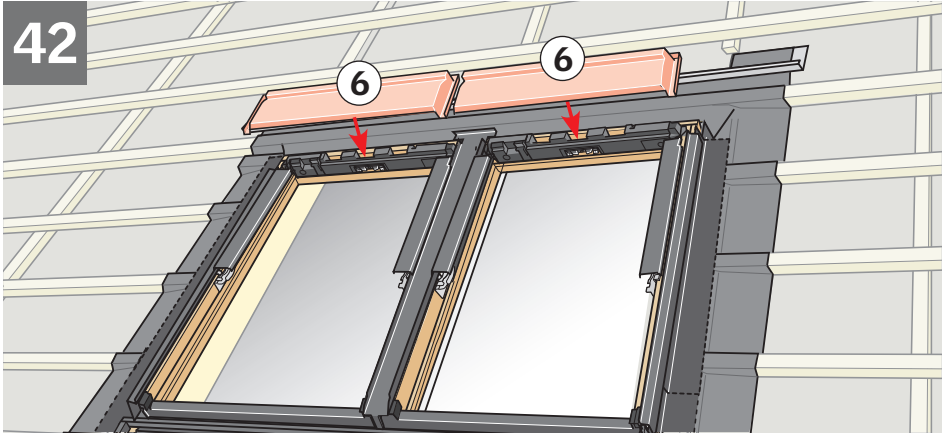

43

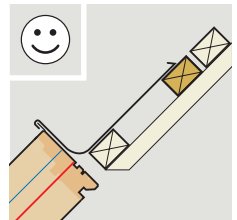
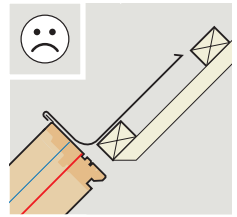
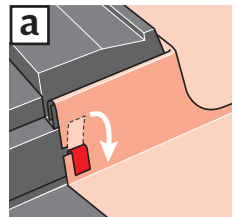
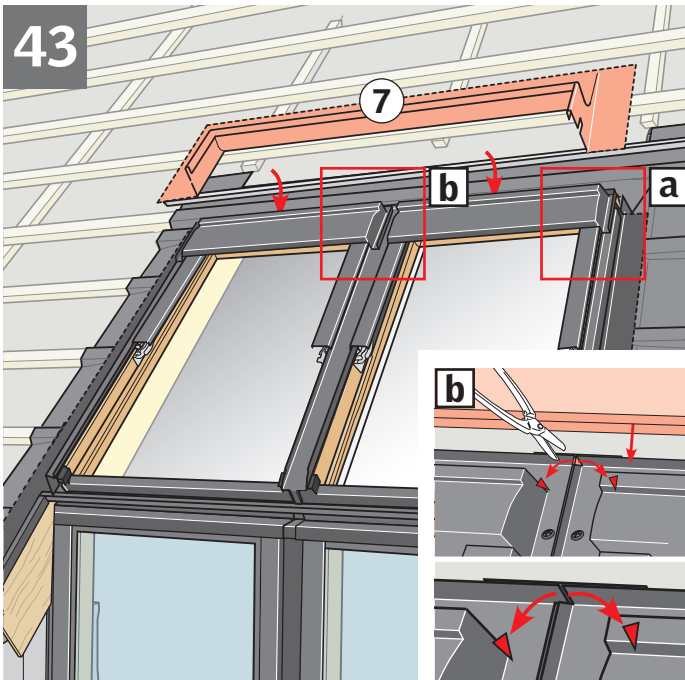

44

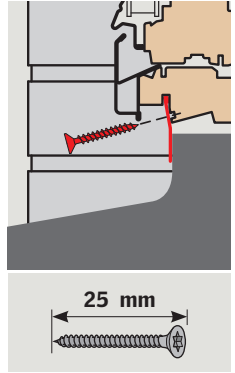
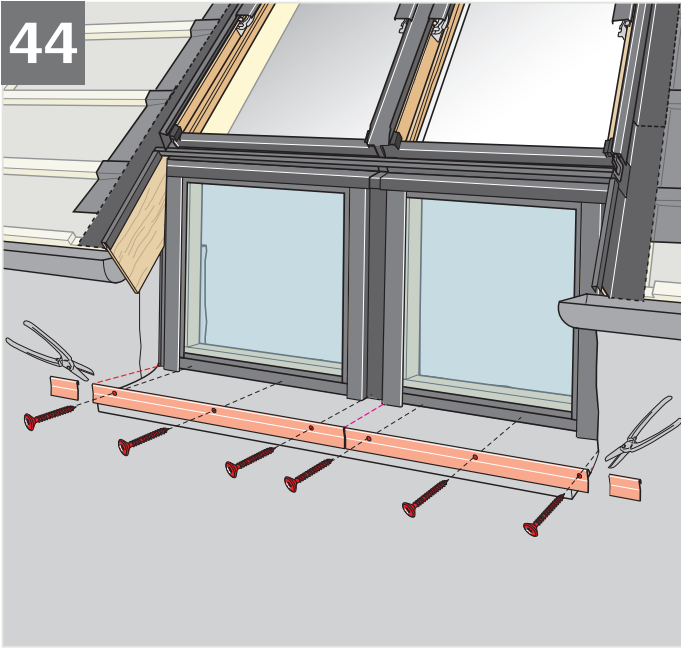

AR: VELUX Argentina S.A. 348 4 639944	HU: VELUX Magyarország Kft. (06/1) 436-0601
AT: VELUX Österreich GmbH 02245/32 3 50	IE: VELUX Company Ltd. 01 848 8775
AU: VELUX Australia Pty. Ltd. 1300 859 856	IT: VELUX Italia s.p.a. 045/6173666
BA: VELUX Bosna i Hercegovina d.o.o. 033/626 493, 626 494	JP: VELUX-Japan Ltd. 0570-00-8145
BE: VELUX Belgium (010) 42.09.09	LT: VELUX Lietuva, UAB (85) 270 91 01
BG: ВЕЛУКС България ЕООД 02/955 99 30	LV: VELUX Latvia SIA 67 27 77 33
BY: Унитарное предприятие "ВЕЛЮКС Мансардные Окна" (017) 329 20 89	NL: VELUX Nederland B.V. 030 - 6 629 629
CA: VELUX Canada Inc. 1 800 88-VELUX (888-3589)	NO: VELUX Norge AS 22 51 06 00
CH: VELUX Schweiz AG 062 289 44 45	NZ: VELUX New Zealand Ltd. 0800 650 445
CL: VELUX Chile Limitada 2 953 6789	PL: VELUX Polska Sp. z o.o. (022) 33 77 000 / 33 77 070
CN: VELUX (CHINA) CO. LTD. 0316-607 27 27	PT: VELUX Portugal, Lda 21 880 00 60
CZ: VELUX Česká republika, s.r.o. 531 015 511	RO: VELUX România S.R.L. 0-8008-83589
DE: VELUX Deutschland GmbH 01806 / 33 33 99 Festnetz: 0,20 €/Anruf Mobilfunk: max. 0,60 €/Anruf	RS: VELUX Srbija d.o.o. 011 20 57 500
DK: VELUX Danmark A/S 45 16 45 16	RU: ЗАО ВЕЛЮКС (495) 640 87 20
EE: VELUX Eesti OÜ 621 7790	SE: VELUX Svenska AB 042/20 83 80
ES: VELUX Spain, S.A. 91 509 71 00	SI: VELUX Slovenija d.o.o. 01 724 68 68
FI: VELUX Suomi Oy 0207 290 800	SK: VELUX Slovensko, s.r.o. (02) 33 000 555
FR: VELUX France 0821 02 15 15 0,119€ TTC/min	TR: VELUX Çati Pencereleri Ticaret Limited Şirketi 0 216 302 54 10
GB: VELUX Company Ltd. 01592 778 225	UA: ТОВ "ВЕЛЮКС Україна" (044) 2916070
HR: VELUX Hrvatska d.o.o. 01/5555 444	US: VELUX America LLC 1-800-88-VELUX